

A SERIES VERTICAL TYPE MODULER BOARD



You  Tube



You can access our montage video by reading the QR code from your phone's camera or the QR code reading applications.

A SERIES VERTICAL TYPE MODULER BOARD

floor standing moduler enclosure



Technical Characteristic

- Color, RAL 7035 Grey
- Modular System for Indoor Application
- Frame&Door: 1,50 mm
- Removable Side and Back Panels
- Depth Adjustable Mounting Plate
- Foamed in Door Gasket
- Base Plate for Floor Installation
- IK 10
- IP55
- IP41
- Disassembled Shipment
- Seismic Test Certification



FRONT VIEW

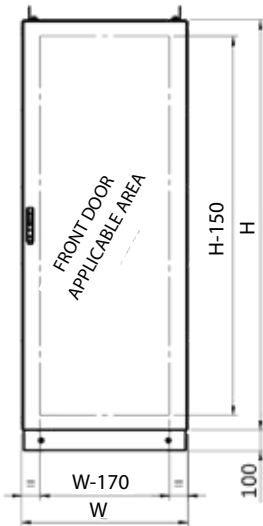

INSIDE VIEW

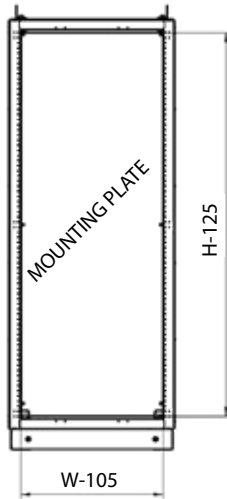

SIDE VIEW

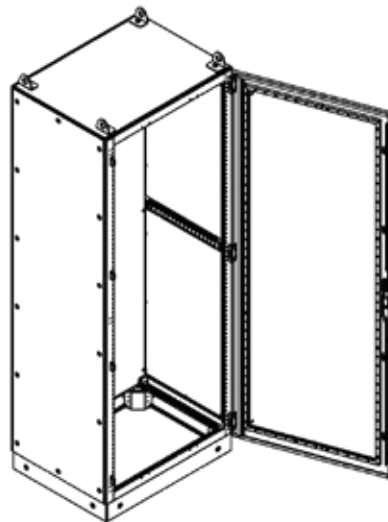
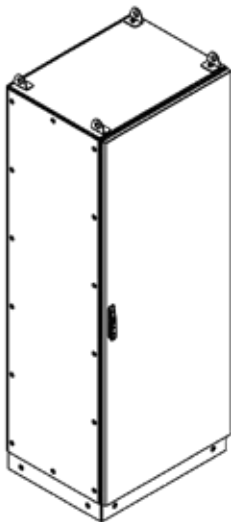
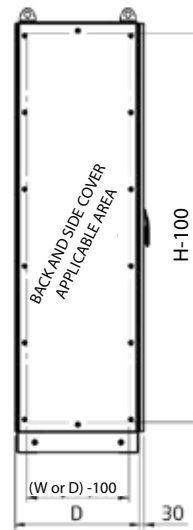

A Series Vertical Type Moduler Board

Code	Dimension (WxHxD)	Pack
CPA 5018040 MPT	500x1800x400	1
CPA 5018050 MPT	500x1800x500	1
CPA 5018060 MPT	500x1800x600	1
CPA 5020040 MPT	500x2000x400	1
CPA 5020050 MPT	500x2000x500	1
CPA 5020060 MPT	500x2000x600	1
CPA 6018040 MPT	600x1800x400	1
CPA 6018050 MPT	600x1800x500	1
CPA 6018060 MPT	600x1800x600	1
CPA 6020040 MPT	600x2000x400	1
CPA 6020050 MPT	600x2000x500	1
CPA 6020060 MPT	600x2000x600	1
CPA 7018040 MPT	700x1800x400	1
CPA 7018050 MPT	700x1800x500	1
CPA 7018060 MPT	700x1800x600	1
CPA 7020040 MPT	700x2000x400	1
CPA 7020050 MPT	700x2000x500	1
CPA 7020060 MPT	700x2000x600	1
CPA 8018040 MPT	800x1800x400	1
CPA 8018050 MPT	800x1800x500	1
CPA 8018060 MPT	800x1800x600	1
CPA 8020040 MPT	800x2000x400	1
CPA 8020050 MPT	800x2000x500	1
CPA 8020060 MPT	800x2000x600	1
CPA 9018040 MPT	900x1800x400	1
CPA 9018050 MPT	900x1800x500	1
CPA 9018060 MPT	900x1800x600	1
CPA 9020040 MPT	900x2000x400	1
CPA 9020050 MPT	900x2000x500	1
CPA 9020060 MPT	900x2000x600	1

TOP VIEW

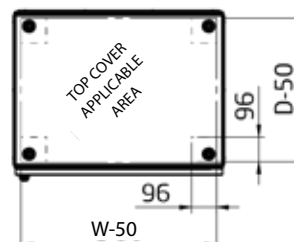

BOTTOM VIEW

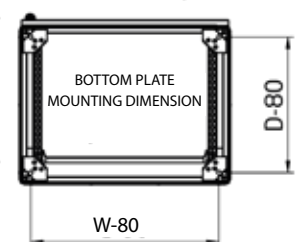

A SERIES VERTICAL TYPE MODULER BOARD

floor standing moduler enclosure



Technical Characteristic

- Color, RAL 7035 Grey
- Modular System for Indoor Application
- Frame&Door: 1,50 mm
- Removable Side and Back Panels
- Depth Adjustable Mounting Plate
- Foamed in Door Gasket
- Base Plate for Floor Installation
- IK 10
- IP55
- IP41
- Disassembled Shipment
- Seismic Test Certification



A Series Vertical Type Moduler Board (Overlapping Door)

Code	Dimension (WxHxD)	Pack
CPA 10018040 MPT	1000x1800x400	1
CPA 10018050 MPT	1000x1800x500	1
CPA 10018060 MPT	1000x1800x600	1
CPA 10020040 MPT	1000x2000x400	1
CPA 10020050 MPT	1000x2000x500	1
CPA 10020060 MPT	1000x2000x600	1

